

Pushing device

000690842.03

R20

User's Guide.

www.sunrisemedical.com

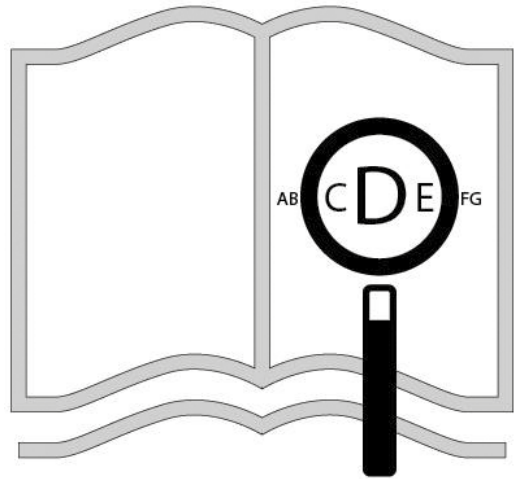

If you are visually impaired, this document can be viewed in PDF format at www.sunrisemedical.co.uk or alternatively is available on request in large text.

Components of the pushing device

We at SUNRISE MEDICAL have been awarded the ISO-9001 certificate, which affirms the quality of our products at every stage, from R & D to production. These products meet the requirements in accordance with EC guidelines

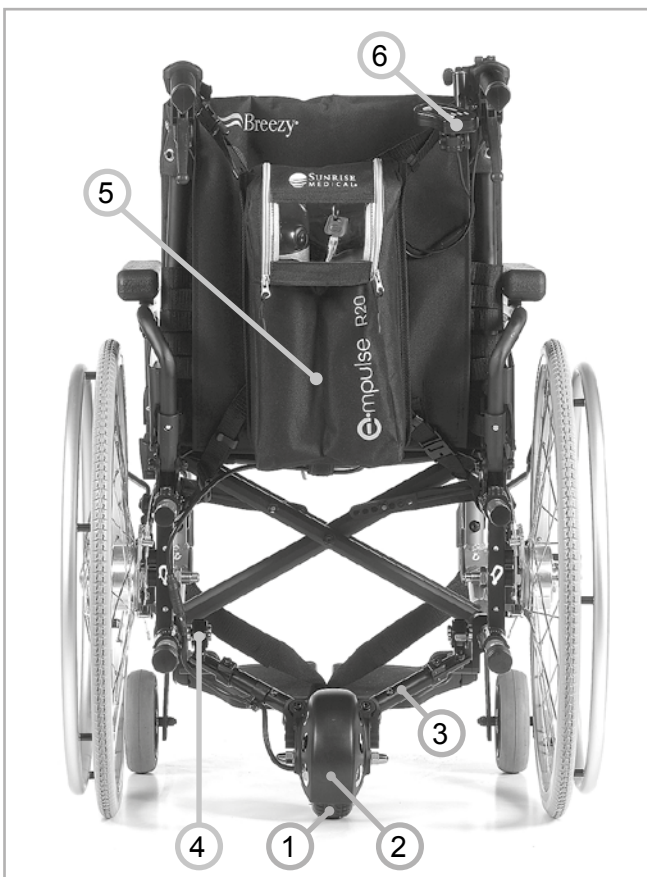
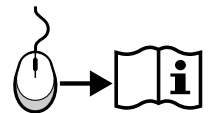

Table of contents









R20 pushing device

1. Drive wheel
2. Mudguard
3. Docking arm
4. Docking clamp
5. Back pack with battery and controller
6. Control unit

Contents

1. Definitions	3
2. Foreword	4
3. Use	4
4. Area of application:	5
5. General safety notes and driving limits	5
6. Safety instructions – prior to each ride	7
7. Safety instructions – while driving	7
8. Warranty	8
9. Delivery	9
10. Starting up	10
10.1 Fitting the pushing device onto the wheelchair	10
10.2 Fitting the back pack onto the wheelchair	10
10.3 Mounting the control unit	10
10.4 Switching on/off	11
10.5 Operating the LED display	11
10.6 Operating the pressure switch	11
11. Battery/Charger	12
11.1 Charging the batteries:	12
11.2 Safety information and precautions on how to transport and ship the battery:	14
12. Transportation	14
13. Safety:	15
14. Maintenance	15
15. Frequency of Service	16
16. Tyre maintenance	16
17. Cleaning/Hygiene	16
18. Disposal / Recycling of materials	17
19. Name plate	17
20. Torque	18
21. Technical data	19
22. Problem solving	20

1. Definitions

Word	Definition
 DANGER!	Advice to the user of Potential Risk of serious injury or death if the advice is not followed
 WARNING!	Advice to the user of a potential risk of injury if the advice is not followed
 CAUTION!	Advice to user that potential damage to equipment may occur if the advice is not followed
 NOTE:	General advice or best practice
	Reference To Additional Documentation
	Does not fit

NOTE:

Please keep a note of your local service agent’s address and telephone number in the space provided. In the event of a breakdown, contact them and try to give all relevant details so they can help you quickly.

The pushing device shown and described in this user guide may not correspond in every detail exactly to your own model. However, all instructions are completely relevant, regardless of possible detail differences. The manufacturer reserves the right to alter without notice any weights, measurements or other technical data shown in this manual. All figures, measurements and capacities shown in this manual are approximate and do not constitute specifications.

Dealer signature and stamp

2. Foreword

Dear Customer,

We are very pleased that you have decided in favour of a high-quality SUNRISE MEDICAL product. This user's manual will provide numerous tips and ideas so that your new pushing device can become a trustworthy and reliable partner in your life.

For Sunrise Medical, it is very important that we have a good relationship with our customers. We like to keep you up-to-date about new and current developments at our company.

Keeping close to our customers means: fast service, as little red tape as possible, working closely with customers. When you need replacement parts or accessories, or if you just have a question about your pushing device – we are there for you. We want you to be satisfied with our products and service. At Sunrise Medical we are constantly working to develop our products further. For this reason, changes can occur in our range of products with regard to form, technology, and equipment.

Consequently, no claims can be construed from the data or pictures contained in this user's manual.

The management system of SUNRISE MEDICAL is certified to EN ISO 9001, ISO 13485 and ISO 14001.

As the manufacturer, SUNRISE MEDICAL, declares that the lightweight wheelchairs conform to the 93/42/EEC / 2007/47/EEC guideline.

Please contact your local, authorised SUNRISE MEDICAL dealer if you have any questions regarding the use, maintenance or safety of your pushing device. In case there is no authorised dealer in your area, or you have any questions about product safety and product recalls, contact Sunrise Medical either in writing or by telephone.

Sunrise Medical
Thorns Road
Brierley Hill
West Midlands
DY5 2LD
England
Phone: 0845 605 66 88
Fax: 0845 605 66 89
www.SunriseMedical.co.uk



Do not use your pushing device until you have read and understood this manual! Please follow the instructions contained within this Owner's Manual.

3. Use

The Empulse R20 is a powered pushing device, which is attached to a wheelchair, to support the mobility and integration of the wheelchair user in daily life. The pushing device is designed for personal use indoors or outdoors by an attendant. Under no circumstances should the wheelchair user operate the pushing device themselves like a wheelchair power drive.

Attention: For safety reasons the attendant must have received training in how to handle the device from a dealer and must be physically and mentally capable of operating the device in all operating situations.

The maximum user weight is marked on the name plate with the serial number. The serial number label is located on the pushing device as well as in the owner's manual.

Warranty can only be taken on if the product is used under the specified conditions and for the intended purposes.

Lifespan

The expected life of the pushing device is 5 years, provided that:

- It is used in strict accordance with the intended use. When operating the pushing device, the values specified by the manufacturer of your wheelchair (for example the maximum slope, the air pressure in the tyres and other specifications), as well as the general operating instructions must be followed precisely and never exceeded.
- All service and maintenance requirements are fulfilled.
- A dealer training course has taken place

DANGER!

Do not fit any unauthorized electronic equipment.

Any combination with other medical devices requires approval directly from Sunrise Medical.

Do not fit any other devices without prior approval, as these could alter the intended use or the structure of the pushing device.

It is essential that you avoid starting up the pushing device before an authorised dealer has carried out a training course on the device!

Note!

Operating the pushing device may interfere with other equipment, for example anti-theft barriers in department stores.

As the pushing device does not have a brake, we always recommend the use of drum brakes.

4. Area of application:

The pushing device provides the attendant with the potential to enable the user to safely cover long distances in an ergonomically and ecologically efficient manner, using their own wheelchair. It significantly extends the activity radius.

The attached wheelchair must be equipped in accordance with road traffic regulations when used on public roads, pavements and spaces.

The max load (user and wheelchair) is 190 kg.

The pushing device can be operated by people who:

- are physically and mentally capable of safely operating the pushing device in all operating situations (uphill, downhill, etc.) and can meet the legal requirements for use on public roads.
- have been advised and trained in its use by Sunrise Medical or an authorised Sunrise Medical dealer.

Operating Conditions

The pushing device should be able to cope with tarmac surfaces and firm paths with different topography. Avoid driving on loose surfaces (e.g. loose gravel, in sand, mud, snow, ice or through deep puddles of water), as this may expose the user to unforeseen risks.

Observe the information on permissible operating conditions in the Instructions for Use for the wheelchair onto which the pushing device is fitted. Any limits regarding the permissible operating conditions (e.g. maximum climbing capability, maximum permissible height of obstacles, max. user weight, etc.) must be observed when using the pushing device!

5. General safety notes and driving limits

The technology and construction of this pushing device have been designed to provide maximum safety. International safety standards currently in force have either been fulfilled or exceeded in parts.

Nevertheless, users may put themselves at risk by using their pushing device incorrectly. For your own safety, the following rules must be strictly observed.

Unprofessional or erroneous changes or adjustments increase the risk of accident. As a user of a pushing device, you are also part of the daily traffic on streets and pavements, just like anyone else. We would like to remind you that you are therefore also subject to any and all traffic laws. Be careful during your first ride in this pushing device. Familiarise yourself with the pushing device.

WARNING!

NEVER exceed the maximum user weight / max. load of 170 kg / 190 kg.

If the max user weight of the attached wheelchair is less than 170 kg, this lower limit will be valid for the complete system. Exceeding the maximum load can lead to damage to the pushing device, loss of control, or serious injury to the user and other people.

- It is essential that you take the user instructions for the wheelchair into account when using the pushing device.
- The wheel locks on the wheelchair to which the pushing device is fitted, must be located so that the attendant pushing the chair can reach them easily.
- Always exercise caution when using the pushing device and always start at the lowest speed level.

For example, avoid negotiating obstacles such as, steps, curbs, path edges or dropping down gaps without slowing down or braking first.

- Your pushing device has not been designed for transportation in a vehicle. When transporting in a vehicle, you must separate the pushing device from the wheelchair!!
- The pushing device should be used exclusively to convey one person at a time, with an attendant pushing. Any other use does not comply with the intended purpose. The pushing device may only be used by an attendant
- Use of the pushing device is only recommended for those who have the appropriate physical and psychological constitution. The individual must be capable of holding the wheelchair and user when tipping backwards or to the side.

- We strongly recommend the use of anti-tips on the wheelchair. On gradients over 8%, two tipping supports are mandatory.
- As a beginner, you should ride particularly carefully at first.
- Familiarise yourself with the handling of the pushing device on level ground first, at the lowest speed level, before you go up or down slopes. In order to be able to go up or down slopes safely, we strongly recommend the use of drum brakes.
- The speed of the pushing device must be adjusted to suit the technical capabilities of the wheelchair, terrain and the attendant. The maximum speed is 5.0 kph. Never exceed this maximum speed under any circumstances.
- At night and dawn/dusk, always use the lights.
- Only ride on asphalt paths, or firm, smooth surfaces.
- Never drive on slopes >10%. The maximum permissible slope as specified by the wheelchair manufacturer must not be exceeded under any circumstances.
- Use caution when riding over curbs, steps, potholes, etc. as there is an increased risk of tipping over. Never drive up steps or go over pits with the power assist switched on.
- Adjust your method of driving to your capabilities.
- Ride slowly and carefully, particularly when riding round corners.
- Do not touch the motor, because it can get very hot.
- Your pushing device should be checked and serviced by your dealer at regular intervals (every two years).
- As with all moving parts, there is a risk that fingers could become trapped. Please always handle carefully.
- If the pushing device is subject to direct sunlight / low temperatures for long periods, parts could become very hot (>41°C) or very cold (<0°). This could cause the motor to heat up and in an extreme case, not be able to operate at full power. Even plastic parts age quicker under intense sunlight.
- Always make sure that the pushing device is properly and safely clicked into the receivers on the wheelchair frame and make sure that the receivers are positioned correctly.
- The pushing device should not be used in storm conditions, heavy rain/snow or on slippery or unpaved surfaces.
- The pushing device may interfere with other equipment, for example anti-theft barriers in department stores.

 **DANGER!**

CHOKING HAZARD – This mobility aid uses small parts which under certain circumstances may present a choking hazard to small children.

6. Safety instructions – prior to each ride

CAUTION!

Check the condition of the pushing device and the wheels of your wheelchair (spokes and rims, damage to tyres) visually and check the tyre pressure.

Low tyre pressure increases the risk of tipping over especially in bends. It also affects the braking action, the wear and tear and the driving performance due to increased rolling resistance.

Always check that the tread depth of your pushing device is Okay. If the tyres have reached their wear limit, then the pushing device must no longer be operated.

Check the fixings by visual inspection for damage (cracks and breakages).

Check that all components, especially the bolts, are tight.

Check the connection between the pushing device and your wheelchair.

Check that the brackets on the frame are correctly positioned.

Check the frame and the components of your wheelchair for any damage, (e.g. cracks)

Ensure that the wheelchair user cannot slip off the foot board of the wheelchair.

Use a special fixing tool if necessary.

Check all cables and electrical connections.

Check that the battery is locked correctly and fully charged.

Switch the battery on.

7. Safety instructions – while driving

WARNING!

Make yourself familiar with the product in flat terrain before driving up or down slopes.

Always hold the pushing handles with both hands firmly as otherwise, there is a high risk of an accident through steering error.

Always adapt your speed to your driving capability and to the traffic - / terrain conditions

Use particular caution when approaching stairs, edges, drops or other hazard areas.

When waiting e.g. at a pedestrian crossing, a traffic light, on hills or slopes or at ramps of any type, always activate the brake.

Always follow the road traffic regulations when driving on public roads and footpaths,

Avoid driving on unpaved or loose surfaces (e.g. on loose gravel, in sand, mud, snow, ice or through deep puddles of water).

Avoid abrupt steering actions

Avoid driving in parallel to slopes

Avoid turning on slopes

The driving style and speed should be always adjusted so that the product can be safely stopped at all times.

Driving on stairs is not permitted.

Obstacles e.g. curbs must be run over always frontal / rectangular with very low speed to avoid tipping over and potential injuries. If necessary, tilt the wheelchair.

It must be avoided that any wheelchair components or parts of your body get trapped when driving over or passing obstacles. This could result in falls and serious injuries as well as damage to the pushing device and wheelchair.

Switch off the product immediately when it is not in use to avoid accidental operation or movements caused by accidentally touching the pushbutton.

Switching off helps to preserve the battery charge.

Where possible, charge the battery pack after every journey.

8. Warranty

YOUR LEGAL RIGHTS ARE NOT LIMITED BY THIS GUARANTEE.

Sunrise Medical* provides a guarantee, as set out in the warranty conditions, for wheelchairs to its customers covering the following.

Warranty conditions:

1. Should a part or parts of the pushing device require repair or replacement as a result of a manufacturing fault within 24 months or for the motor within 3 years after delivery to the customer, then the affected part or parts will be repaired or replaced free of charge. The warranty will only cover manufacturing defects
2. To enforce the warranty, please contact Sunrise Medical Customer Service with the exact details of the nature of the difficulty. Should you be using the wheelchair outside the area covered by the Sunrise Medical customer service agent, repairs or replacement will be carried out by another agency as designated by the manufacturer. The wheelchair must be repaired by a customer service centre/dealer designated by Sunrise Medical.
3. For parts, which have been repaired or exchanged within the scope of this warranty, we provide a warranty in accordance with these warranty conditions for the remaining warranty period for the wheelchair in accordance with point 1).
4. For original spare parts which have been fitted at the customer's expense, these will have a 12 months guarantee, (following the fitting), in accordance with these warranty conditions.
5. Claims from this warranty shall not arise, if a repair or replacement of a wheelchair or a part is required for the following reasons:
 - a. Normal wear and tear, which include batteries, armrest pads, upholstery, tyres, brakes shoes, etc.
 - b. Any overloading of the product, please check the EC label for maximum user weight.
 - c. The product or part has not been maintained or serviced in accordance with the manufacturer's recommendations as shown in the user instructions and/or the service instructions.
 - d. Accessories have been used which are not specified as original accessories.
 - e. The wheelchair or part having been damaged by neglect, accident or improper use.
 - f. Changes/modifications have been made to the wheelchair or parts, which deviate from the manufacturer's specifications.
 - g. Repairs have been carried out, before our Customer Service has been informed of the circumstances.

6. This guarantee is subject to the law of the country in which the product was purchased from Sunrise Medical*

* Means the Sunrise Medical facility from which the product was purchased.

Liability

If the pushing device is:

- handled improperly
- not maintained in accordance with the maintenance schedule
- commissioned and used contrary to the instructions in this manual
- repairs or other works are carried out by non-authorised persons, third-party parts are installed or connected without prior agreement with Sunrise Medical, then Sunrise Medical GmbH is not responsible for the safety of the pushing device.

9. Delivery

Your new pushing device is delivered fully assembled in a cardboard box. In order to avoid any damage during transportation, loose parts or parts to be fitted, are packed separately in the cardboard box.









Take the pushing device carefully out of the box and check that it is complete. Check all parts for surface damage, scratches, cracks, dents, distortions and other defects.

Unpacking:

Check the shipping cardboard box for external damage which may have been caused during transportation. Remove all packaging material.

NOTE: Should you find any damage, or if any parts are missing please let us know immediately.

The delivery of the pushing device contains:

Delivery	Description	Quantity
	Drive wheel with integrated motor including brackets	1
	Back pack with LI-ION 36V/5.8Ah battery with battery bracket and 2 keys, motor controller	1
	Control unit (in the back pack)	1
	LI-ION 36V/5.8Ah battery for wheelchair (in the back pack)	1
	Battery bracket, 2 keys (in the back pack)	
	Motor controller 36V / 15A (in the back pack)	1
	Docking clamps (1 clamp on the Ibis)	2
	Charger 36 V 1.35 A	1

10. Starting up

10.1 Fitting the pushing device onto the wheelchair (Fig. 10.1)

Open the lock by pressing the release button (M) on the lever on both sides and plug the connector (D) on the wheelchair frame. Ensure that the lock is fully clicked into place.

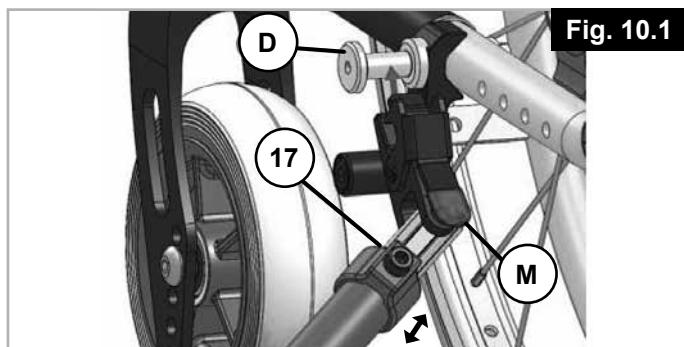

⚠ CAUTION!

The pushing device may only be used with the delivered docking system and the suitable docking pins for your wheelchair.

The pushing device must be handed over ready to use from Sunrise Medical or an authorised Sunrise Medical dealer. Changing the bracket for the pushing aid must only be carried out by Sunrise Medical or the authorised health care specialist.

⚠ WARNING!

As with all moving parts, there is a risk that fingers and / or clothing could become trapped. Please always handle carefully.

10.2 Fitting the back pack onto the wheelchair (Fig. 10.2)

Connect the four corners of the back pack with the buckle (T1) of the retaining straps. Adjust the straps (T2) to the required width for your wheelchair. Any surplus strap can be fixed using the retaining clips (T3).

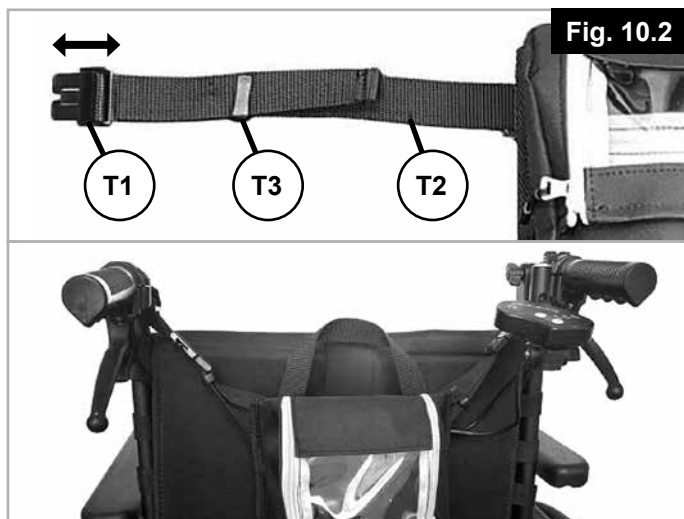

10.3 Mounting the control unit (Fig. 10.3)

Fix the control unit to the bracket using the wing bolt (24). The optimal position can be set for the pushbutton (W) by undoing or removing the screw fitting (21) and the display can be adjusted by undoing the screw (21). Then re-tighten all screws.

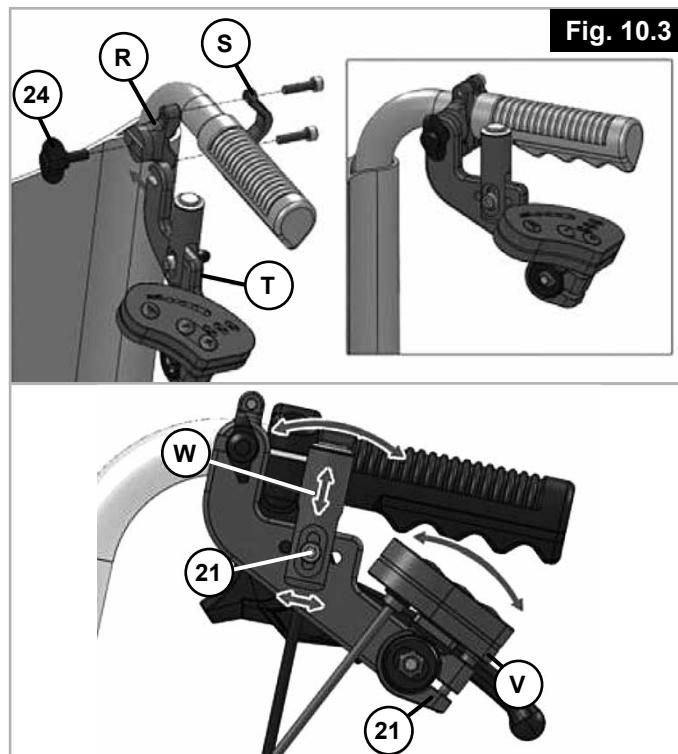

By undoing the wing bolt (24), the control unit (T) can be fully removed and stored in the back pack. To do this, pull the control unit (T) through the rear zip fastening of the back pack and store it in the right back pack pocket.

10.4 Switching on/off (Fig. 10.4)

To switch the drive system on and off, use the button (A1) on the battery. After switching on, the individual LEDs of the battery capacity display light up yellow one after another and then remain lit up or go off, depending on the level of charge.

You do not need to open the back pack to reach this button (A1). The battery can be switched on and off through the transparent viewing window.



Fig. 10.4

Attention: The on/off switch is also the emergency stop switch. It must therefore always be freely accessible.

! WARNING!

When the wheelchair is parked, the battery must always be switched off!

! CAUTION!

Before using for the first time, the battery should be fully charged.

! WARNING!

The surface temperature of the charger can rise to 49°C during charging.

10.5 Operating the LED display (Fig. 10.5)

The display contains LED displays for the battery charge status, LED displays for the 3 drive levels and 2 operating keys for the drive level selection.

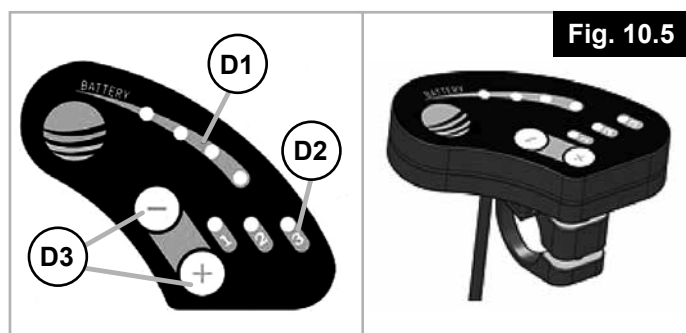

Fig. 10.5

D1 = BATTERY CHARGE LEVEL DISPLAY

D2 = DRIVE LEVEL DISPLAY

D3 = SETTING BUTTON FOR DRIVE LEVELS

After switching on, drive level 1 is always set. You can use the “-” and “+” keys to select. Depending on the drive level set, the maximum speed is limited to:

Drive level 0 = no LEDs on = 0 kph (OFF)	(0 LEDs on)
Drive level 1 = first LED on = 2 kph	(1 LED on)
Drive level 2 = first and second LEDs on = 3.7 kph	(2 LEDs on)
Drive level 3 = first, second and third LEDs on = 5 kph	(3 LEDs on)

10.6 Operating the pressure switch (Fig. 10.6)

Pressing the pushbutton (1) will activate the pushing device and it will drive at the set maximum speed for as long as the pushbutton is being pressed. When you let go, the pushing device is deactivated.



Fig. 10.6

Attention: The pushing device is not a braking aid. The wheelchair must be braked by the attendant. This is why we recommend drum brakes.

! WARNING!

The pushbutton must never be locked in position!! If the pushing device is switched on, each time the pushbutton is pressed, the pulse is converted into a drive command. You should therefore make sure that the pushbutton is not pressed unintentionally. Switch the pushing device off when stopping or waiting at potential hazardous areas (e.g. while waiting for a pedestrian traffic light, on uphill and downhill gradients or on ramps of any type) and take your hands off the pushbutton.

11. Battery/Charger

Before using for the first time, charge the battery fully! The battery can be charged on the wheelchair, or separate from the wheelchair. The battery is locked in the back pack using a padlock. In order to remove the battery, you must first open the padlock. Turn the key anti-clockwise. The padlock is now unlocked you can flip the battery forwards and pull it out of the bracket.

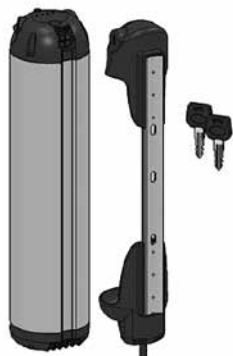

In order to refit the battery, push the battery into the back pack bag from underneath so that the bottom of the battery slides into the bottom bracket. Now push the battery into the upper bracket. In order to stop the pushing device being stolen and for final fixing, lock the padlock again by turning the key in a clockwise direction. To be able to drive, remove the key from the padlock.

Attention: Please always take a key with you and keep a second key in a second place.

11.1 Charging the batteries: (Fig. 11.1)

Open the end cap (A2) to charge the device and connect the charging plug (A3) of the charger.



Then connect the charger to the socket using the mains plug. During the charging process, the display on the charger lights up red; as soon as the battery is fully charged, the display lights up green. The charging progress is not shown on the battery itself.

Charging temperature:	0°C to 45°C
Charging time:	approx. 4.5 - 5 hours
Storage:	5°C to 25°C (recommended)
Storage:	-20°C to 45°C (Limit)

We would recommend that you charge the battery after each journey. Before long periods of non-use, the battery should be fully charged. When not being used, the battery should be re-charged every 12 weeks, in order to avoid damage to the battery. It should only be stored in a dry environment.

After successful charging, remove the mains plug of the charger from the socket and pull the charging plug out of the charging socket of the battery. Close the charging socket using the end cap, in order to prevent water ingress and corrosion.

You can obtain information on the state of charge of the battery using a charge level indicator. To do this you must press the button in the centre of the display briefly. After that, the state of charge will be shown for a short period of time using light diodes.

Please also note the information on the rating plate on the bottom of the battery:

Avoid direct sunlight and high temperatures. The battery must only be used at ambient temperatures between -20 °C and +60 °C.



Keep the battery away from open flames



CE mark (Conformity Europe), this battery meets the designated European standards



Cells contain lithium



The battery must not be disposed of as household waste



China RoHS marking: There are dangerous materials used. The number in the logo indicates how many years the product can be used as intended.



Warning: Using an unsuitable battery charger can lead to malfunction and result in the battery having a limited service life. There is a danger of fire and explosion.



The charger must not be disposed of as household waste



The charger must only be used indoors

- You must only use the appropriate charger for this battery from SUNRISE MEDICAL
- When using the battery charger, please note the printed instructions on the battery charger and the following provided information.
- Ensure that the plug is firmly inserted in the socket.
- Never touch plugs with wet hands.
- Do not use the plug of the charger and/or the mains plug if they are wet or dirty. Before inserting it, clean the plug using a dry cloth.
- Do not expose the charger to moisture of any kind during charging (water, rain water, snow, etc.).
- Do not cover the charger during the charging process or place any objects on top of the device.
- Do not carry out the charging process in rooms where moisture may affect the charger.

- Be aware of condensation. If the charger is brought from a cold into a warm room, condensation may form. In this case, refrain from using the charger until all condensation has dissipated. Please note that this may take several hours.
- Never carry the charger by its power cable or the charger cable.
- Do not leave the charger connected to the mains socket any longer than necessary.
- Never tug at the power cable to disconnect the charger from the mains socket.
- Never subject cable and plug to any pressure. Overstretching or bending the cable, pinching a cable or placing heavy objects on a cable or a plug may result in electric shock or fire.
- Avoid short circuits.
- When charging, place the battery on a non-flammable, heat-resistant surface. There should not be any flammable or highly-combustible objects near the battery.
- Never leave the battery unattended during charging
- Damaged batteries must not be recharged or used any further.
- Batteries are not toys and must not be used by children!
- Lay the power cable and the attached charging cable so that nobody can step on it or trip over it and so both cables are not subject to any other harmful effects or stress.
- Do not operate the charger if the power cable, the charging cable or the plugs attached to the cables are damaged. Damaged parts must be replaced immediately by the authorised specialist dealer.
- Do not use or disassemble the charger when it has received a hard blow or was dropped or damaged in another way. Take the damaged charger to a specialist dealer who has been authorised to perform repairs.
- Original plugs and cables must not be cut off or modified.
- Never attempt to disassemble or modify the charger.



Improper handling can lead to risks such as explosions, overheating or fire. Non-observance of the instructions for use can lead to premature wear or other defects. These instructions must be stored safely.

11.2 Safety information and precautions on how to transport and ship the battery:

⚠ WARNING!

Lithium-ion cells are used in the battery. Transport and shipping of the battery are, therefore, subject to all applicable statutory requirements, which must be strictly observed. For instance, a defective battery must never be transported by plane.

If your battery is defective, take it personally to your specialist dealer as shipping lithium-ion batteries by post or other carriers is subject to strict rules and regulations. Once again, we recommend that you contact your specialist dealer.

As transport regulations may change annually, we strongly recommend that you consult your travel operator, airline or shipping line before you set out on your trip in order to learn about the current applicable regulations. A defective battery must not be taken on a plane or put in your luggage.

⚠ CAUTION!

If your battery is fitted to the pushing device when being transported, relaxed transport regulations apply in accordance with UN3171.

Make sure you keep the packaging container of the battery in case you need to transport it. Discuss transportation with your specialist dealer prior to shipping.

12. Transportation

The pushing device has not been designed for transportation in a vehicle.

⚠ WARNING!

When transporting in a vehicle, do NOT remain seated in the wheelchair with the pushing device fitted. Always use a properly secured vehicle seat.

The product and all its components must be secured during transport so that they are not damaged (e.g. by falling over) and do not become any risk to other people. In this case the pushing device can remain on the wheelchair. The wheelchair can still be folded, even with the pushing device fitted (in so far as this wheelchair is able to fold). The procedure for folding/unfolding is described in the user instructions from your wheelchair manufacturer.

⚠ CAUTION!

When transporting make sure that the cables are not caught up, become kinked or otherwise damaged. The pushing device may not be used with damaged cables.

Disassembly for transportation

For transportation, the pushing device can be removed without the need for tools.

Open the lock by pressing the red lever (M) on both sides and remove the pushing device from the wheelchair (Fig. 12.1).

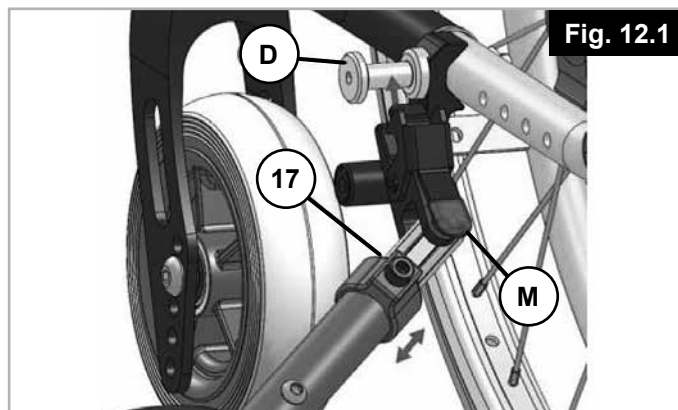
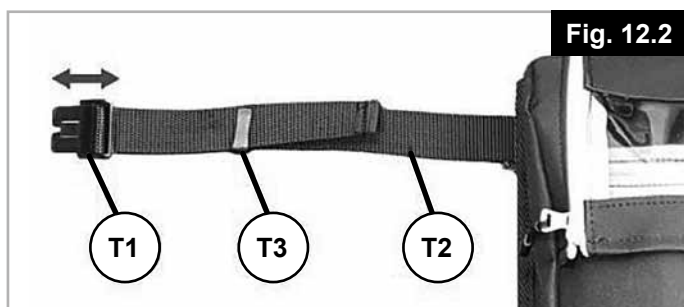
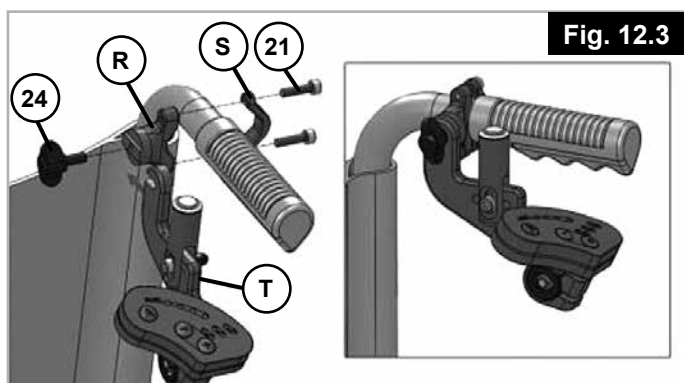

Fig. 12.1

Undo the 4 straps of the back pack with the buckle (T1) on the retaining straps of the wheelchair (Fig. 12.2).



Undo the wing bolt (24) in order to remove the controller unit (T) completely and store in your back pack. To do this, pull the control unit (T) through the rear zip fastening of the back pack and store the control unit in the right back pack pocket (Fig. 12.3).



You can fix the pushing device on the rear of the back pack using the Velcro straps.

13. Safety:

Never leave the pushing device unattended, whether it is switched on or switched off.

In order to stop the pushing device being stolen and against unauthorised use, switch the pushing device and remove the battery.

14. Maintenance

The R20 pushing device is extremely low maintenance. We recommend that the R20 is checked by a dealer every 2 years.

Before any maintenance is started, turn the battery off and remove it.

NOTE: All service and maintenance procedures carried out on the pushing device require the battery locking key. Without this key no maintenance is possible.

Maintenance plan	after 24 months
Functionality test und safety check of the docking system (pushing device and wheelchair)	X
Visual check of the docking system, the back pack fixing for damage (tears, distortions, etc.)	X
Visual check of the wheelchair frame, the backrest tubes for damage (tears, distortions, dents, etc.)	X
Check the tyres (profile depth, tears, damage; and replace if necessary)	X
Check all cables and plug connections	X

15. Frequency of Service

Servicing:

If you have any questions or require any help, please contact your authorised Sunrise Medical dealer.

Depending on how much you have used your pushing device, we recommend that you take it to your dealer at least every 2 years, to have your pushing device inspected by trained personnel.

16. Tyre maintenance

The pushing device is fitted with a 6" drive wheel with a solid tyre. Make sure that the tyres have sufficient tread, as this will significantly affect the driving characteristics. When the tyre is worn (see Fig.) it must be replaced by an authorised dealer.

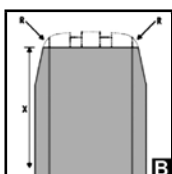
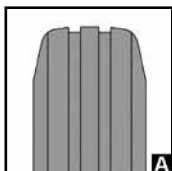

17. Cleaning/Hygiene

The pushing device should be cleaned regularly and after each bigger journey with commercially available, household cleaning agents. If needed only use a little water.

The pushbutton, display and battery may only be cleaned by wiping with a damp (not wet) cloth.

The drive wheel can be cleaned with a soft sponge or a soft brush.

The docking pins at the wheelchair and the docking system can be cleaned with water, a soft sponge or a soft brush (recommended after each ride).



CAUTION!

Never use steam or high pressure to clean the product.

Never use any abrasive cleaning agents or aggressive, acidic cleaners.

Make sure that water will not get into contact with the electrical connectors.

Hygiene when being reused:

When the pushing device is to be reused, it should be prepared carefully, and be wiped and treated with spray disinfectant on all surfaces which could come into contact with the user. If you need to do this quickly, you must use a liquid, alcohol based disinfectant suitable for medical products and devices. Please pay attention to the manufacturer's instructions of the disinfectant you are using.

18. Disposal / Recycling of materials

Materials Used:

In the following section, there is a description of the materials used on the pushing device, in view of the disposal or recycling of the pushing device and packaging.

There may also be special local regulations in force with regard to disposal or recycling, these must be taken into account when disposing of your pushing device.

(This can include the cleaning or decontamination of the pushing device prior to disposal).

Aluminium: Brackets, controller

Steel: Screws

Stainless Steel: Docking bolts, pushbutton, release catch

Plastic: Handles, plug, display cover, display, charger, controller box

Rubber: Tyres

Polyester: Back pack

Packaging: Made of soft polyethylene, cardboard

Battery: Lithium Ion battery (hazardous product)

Please see battery section for more detailed information.





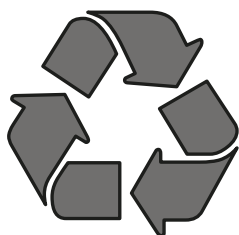





NOTE: Disposal or recycling should be done through a licensed agent or authorised place of disposal.













Alternatively your pushing device may be returned to your dealer for disposal.



19. Name plate

The nameplate is located on the frame as well as on a label in the owner's manual. The nameplate indicates the exact model designation and other technical specifications. Please provide the following pieces of information whenever you have to order replacement parts or to file a claim:

 Sunrise Medical GmbH Kahlbachring 2-4 69254 Malsch / GERMANY	Distributor
 XX.XX.XXXX	Date of manufacture
S.N. 4050063593601	Serial Number
 max. 10°	Max gradient (10°/18%)
 Max 190 kg	Max. load capacity (user + wheelchair)
 5 km/h	Max speed
 36 Volt	Electrical voltage / V=Volt
 250 Watt	Motor performance
 Li-ion	Cells contain lithium
	Must not be disposed of as household waste
	CE Mark
	You must follow the instructions in the user guide.

 SUNRISE MEDICAL	 Sunrise Medical GmbH Kahlbachring 2-4 69254 Malsch-HD / GERMANY	 2019-05-03
Power Push Device		S.N. 4050063593601
e-mpulse R20		07500000-000
 max. 10°	 Max 190 kg	 5 km/h
 36 Volt	 250 Watt	 
		

As we are committed to continually improving the construction of our wheelchairs and pushing devices, product specifications may vary slightly from the examples illustrated. All weight/dimensions and performance data is approximate and is provided solely for guidance.

All products from Sunrise Medical comply with the 93/42/EEC directive for medical products.

All pushing devices must be used in accordance with the manufacturer's guidelines.

Sunrise Medical
Thorns Road
Brierley Hill
West Midlands
DY5 2LD
England
Phone: 0845 605 66 88
Fax: 0845 605 66 89
www.SunriseMedical.co.uk

20. Torque

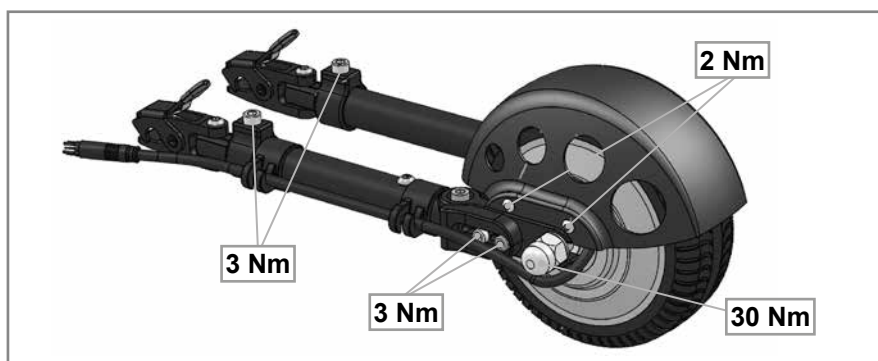

The screws used are fitted with threadlock at the factory and after fitting, cannot be re-used. After that they should be replaced or alternatively re-secured with threadlock to medium tightness.



WARNING!

Secured nuts may only be used once.

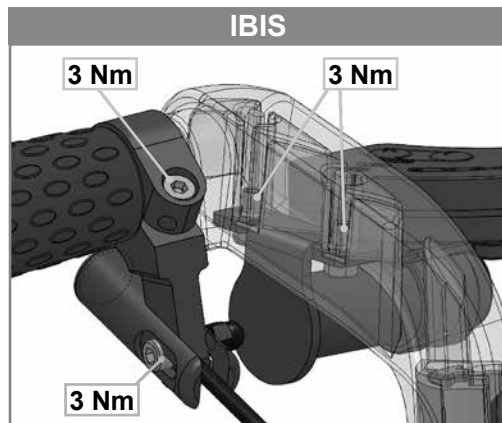
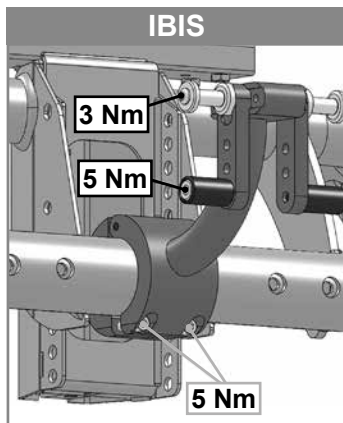
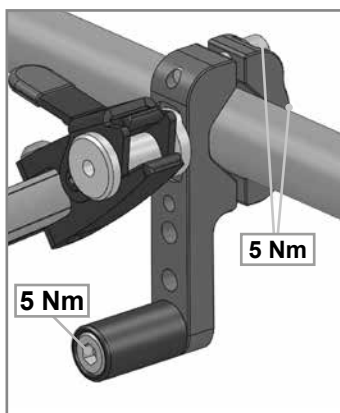
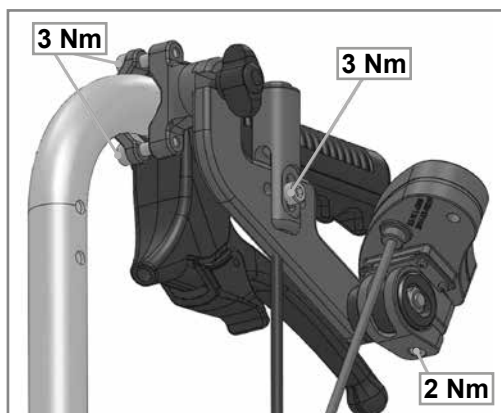

21. Technical data

General data:	
Battery	36 V, 5.8 Ah Li-Ion
Operating Voltage:	36 Volt
Range:	up to 15 km*
Speed, can be pre-selected:	1 - 5 kph in 3 levels (2/3.7/5 kph) **
Climbing power:	up to 18% (10°)
Max user weight / load:	170 kg / 190kg
Total weight:	4.5 kg (10 lbs)
Weight of drive unit:	3 kg
Weight of battery pack:	1.4 kg

Motor data:	
Rated voltage	36 Volt
maximum current	15 A
Continuous rated power	250 W
Maximum torque	30 Nm
Protection Rating	IP54
Serial Number	Laserprint example ASM 160706 00516 = Serial number 00516
Wheel size	6"
Motor noise	max. 50 +/-5 dbA at 1 m distance
Motor temperature (normal operation)	max 41°C
Warranty	3 years

Battery data:	
Rated voltage	36 Volt
Capacity (nominal charge)	5.8 Ah
Electrical power	209 Wh
Discharge current	15 A (5 sec)
	10 A (10 min)
	8A (continuous)
Charging time	4.5 - 5 h (approx. at 1.35 A charging current)
Temperature in normal operation	max. 41°C
Charging temperature range	0 - 45°C
Operating temperature	-20° to 60°
Storage temperature range	-20° to 35°C (1 year)
	-20° to 50°C (1 week)
	-20° to 45°C (1 month)
	-20° to 40°C (6 months)
Protection Rating	IP65
Serial Number	Laserprint on the underside after the model name > example AWB1805466822D Serial number 466822
Warranty	2 years
Display	State of charge
Functions	On/off switch; lockable
Fuse	5x20 with 15 A replaceable glass fuse
UN Test Certificate	present

Charger:	
Input	100-240V AC
End-of-charge voltage / current	42V / 1.35A
Fuse	3.15 A safety fuse
Serial Number	none
Surface temperature	up to 49°C

Controller:	
Rated voltage	36 Volt
Maximum current	15 A
Nominal current	7 A
Protection Rating	IP56
Serial Number	Label after Product number > example X1803033879 Serial number 033879

Display:	
Displays	Battery state of charge (4 LED)
	Drive level (3 LED)
Function	Selection of drive levels 0, 1, 2, 3
Protection Rating	IP65

Pushbutton	
Protection Rating	IP65

* Depending on the wheelchair – pushing device combination values can vary e.g. surface conditions, user weight, driving capability, add-on weight, topography.

** The maximum speed depends on user weight, topography, air pressure, surface conditions.

22. Problem solving

Problem	Check		Solution
R 20 cannot be switched on	Battery connected properly	no	Plug in properly
	Battery switched on	no	Switch on
	Battery charged	no	Charge
	Fuses in battery are defective	yes	Contact dealer
	Problem still present	yes	Contact dealer

R 20 doesn't move	R 20 switched on	no	Switch on
	Cable plugged in properly	no	Plug in properly
	Battery discharged	yes	Charge
	Drive wheel on the floor	no	Unhook drive wheel
	Drive wheel has traction	no	Contact dealer
	Problem still present	yes	Contact dealer

Battery cannot be charged	Charger plugged in correctly	no	Plug in properly
	Device plug is plugged in properly	no	Plug in properly
	Problem still present	yes	Contact dealer
	Incorrect charger	yes	Use the original charger

Battery damaged	The battery must not be opened - notify dealer		
-----------------	--	--	--







Sunrise Medical S.r.l.
Via Riva, 20 – Montale
29122 Piacenza
Italia
Tel.: +39 0523 573111
Fax: +39 0523 570060
www.SunriseMedical.it

Sunrise Medical AG
Erlenauweg 17
CH-3110 Münsingen
Schweiz/Suisse/Svizzera
Fon +41 (0)31 958 3838
Fax +41 (0)31 958 3848
www.SunriseMedical.ch

Sunrise Medical AS
Delitoppen 3
1540 Vestby
Norge
Telefon: +47 66 96 38 00
Faks: +47 66 96 38 80
post@sunrisemedical.no
www.SunriseMedical.no

Sunrise Medical AB
Neogatan 5
431 53 Mölndal
Sweden
Tel.: +46 (0)31 748 37 00
post@sunrisemedical.se
www.SunriseMedical.se

MEDICCO s.r.o.
H – Park, Heršpická 1013/11d,
625 00 Brno
Czech Republic
Tel.: (+420) 547 250 955
Fax: (+420) 547 250 956
www.medicco.cz
info@medicco.cz
Bezplatná linka 800 900 809

Sunrise Medical ApS
Park Allé 289 G
DK-2605 Brøndby
Tlf. 70 22 43 49
Email: info@sunrisemedical.dk
www.SunriseMedical.dk

Sunrise Medical Pty. Ltd.
6 Healey Circuit, Huntingwood,
NSW 2148,
Australia
Phone: 9678 6600,
Orders Fax: 9678 6655,
Admin Fax: 9831 2244.
Australia
www.sunrisemedical.com.au

Sunrise Medical
North American Headquarters
2842 Business Park Avenue
Fresno, CA, 93727, USA
(800) 333-4000
(800) 300-7502
www.SunriseMedical.com



Sunrise Medical GmbH
Kahlbachring 2-4
69254 Malsch/Heidelberg
Deutschland
Tel.: +49 (0) 7253/980-0
Fax: +49 (0) 7253/980-222
www.SunriseMedical.de

Sunrise Medical
Thorns Road
Brierley Hill
West Midlands
DY5 2LD
England
Phone: 0845 605 66 88
Fax: 0845 605 66 89
www.SunriseMedical.co.uk

Sunrise Medical S.L.
Polígono Bakiola, 41
48498 Arrankudiaga – Vizcaya
España
Tel.: +34 (0) 902142434
Fax: +34 (0) 946481575
www.SunriseMedical.es

Sunrise Medical Poland
Sp. z o.o.
ul. Elektronowa 6,
94-103 Łódź
Polska
Telefon: + 48 42 275 83 38
Fax: + 48 42 209 35 23
E-mail: pl@sunrisemedical.de
www.Sunrise-Medical.pl

Sunrise Medical B.V.
Groningenhaven 18-20
3433 PE NIEUWEGEIN
The Netherlands
T: +31 (0)30 – 60 82 100
F: +31 (0)30 – 60 55 880
E: info@sunrisemedical.nl
www.SunriseMedical.nl

Sunrise Medical HCM B.V.
Vossenbeemd 104
5705 CL Helmond
The Netherlands
T: +31 (0)492 593 888
E: customerservice@
sunrisemedical.nl
www.SunriseMedical.nl
www.SunriseMedical.eu
(International)

Sunrise Medical S.A.S
ZAC de la Vrillonnerie
17 Rue Mickaël Faraday
37170 Chambray-Lès-Tours
Tel : + 33 (0) 247554400
Fax : +30 (0) 247554403
www.sunrisemedical.fr

